

50
years
1958-2008

Circuit-breakers



- circuit-breakers up to 25 A
- circuit-breakers up to 63 A
- additional features
- accessories



Declaration of conformity RoHS

RELPOL S.A.
ul. 11 Listopada 37
68-200 Żary, Poland

RELPOL S.A. hereby confirms that circuit-breakers, additional features and accessories supplied by our company meet the requirements of the Directive 2002/95/EC "RoHS".

1.11.2005 r.

A. Hyska
R&D Department, Director
Andrzej Hyska



www.relpol.com.pl

Circuit-breakers

Circuit-breakers up to 25 A

RMSI25 4



Circuit-breakers up to 63 A

RMSI25 4



Additional features

RSI-C11, RSI-S 5

RSI-U, RSI-W 5

RSI-M 5



Accessories

RSI-L 6

RSI-BO4, RSI-A 6



Technical data 7

Connections diagrams 11

Dimensions 12

Requirement regarding space ... 13

Mounting positions 13

Connection of additional features and accessories to circuit-breaker 15

The **RMSI25, RMSI63 circuit-breakers** are compact circuit-breakers for currents up to 63 A. The devices are used for switching and protecting motors or other loads. They are fitted with instantaneous overcurrent releases and inverse-time delayed overload relay. Circuit-breakers and contactors can be combined to form fuseless starter combinations.

The RMSI25, RMSI63 circuit-breakers are suitable for use in any climate. They are designed for operation in enclosed rooms, under good operating conditions (e.g. no dust, corrosive steam or damaging gases). They must be suitably encapsulated before being installed in dusty and humid rooms. The standards to which the breakers have been constructed, permissible ambient temperatures, maximum making and breaking capacity, tripping currents and other limiting operational conditions are given in the technical data in catalogue and on website www.repol.com.pl



Circuit-breakers for motor protection:

RMSI25 (0,1...25 A), RMSI63 (1...52 A): the characteristic curves of these circuit-breakers are specially laid-out for the overload and short-circuit protection of motors. They are fitted with inverse-time delayed overload releases and instantaneous electromagnetic overcurrent releases - short-circuit releases. The inverse-time delayed releases are adjustable for setting the rated current of the motors to be protected. The instantaneous short-circuit releases are fixed-set to 12 times the value so as to assure faultless starting of the motors.

Circuit-breakers for plant protection:





RMSI25 (0,1...25 A), RMSI63 (1...63 A): the circuit-breakers are used for the protection of cables, conductors and plant equipment against thermal overload and short-circuit. There are fixed-setting overcurrent releases (short-circuit releases) and adjustable overload releases (thermal releases).

Circuit-breakers for starter combination:





RMSI63 (1,6...52 A): in starter combinations consisting of a contactors and circuit-breakers these breakers are used for short-circuit protection of these combinations.

Circuit-breakers

4

RMSI25	Ordering codes	Rated current I_n [A]	Three-phase motor power [kW] ❶	Setting range [A]		Weight [kg]
				thermal overload release 	instantaneous overcurrent release 	
NEW product  	RMSI25-0V16	0,16		0,1 - 0,16	1,9	0,29
	RMSI25-0V24	0,24	0,06	0,16 - 0,24	2,9	
	RMSI25-0V4	0,4	0,09 / 0,12	0,24 - 0,4	4,8	
	RMSI25-0V6	0,6	0,12 / 0,18	0,4 - 0,6	7,2	
	RMSI25-1	1	0,25	0,6 - 1	12	
	RMSI25-1V6	1,6	0,37 / 0,55	1 - 1,6	19	
	RMSI25-2V4	2,4	0,75	1,6 - 2,4	29	
	RMSI25-3V2	3,2	1,1	2 - 3,2	38	
	RMSI25-4	4	1,1 / 1,5	2,4 - 4	48	
	RMSI25-5	5	1,5 / 2,2	3,2 - 5	60	
	RMSI25-6	6	2,2	4 - 6	72	
	RMSI25-8	8	3	5 - 8	96	
	RMSI25-10	10	3 / 4	6 - 10	120	
	RMSI25-13	13	4 / 5,5	8 - 13	156	
	RMSI25-16	16	7,5	10 - 16	190	
	RMSI25-20	20	7,5	14 - 20	240	
RMSI25-25	25	11	18 - 25	300		

Circuit-breakers
up to 25 A







RMSI63	Ordering codes	Rated current I_n [A]	Three-phase motor power [kW] ❶	Setting range [A]		Weight [kg]
				thermal overload release 	instantaneous overcurrent release 	
NEW product  	RMSI63-16	16	5,5 / 7,5	10 - 16	190	0,76
	RMSI63-25	25	11	16 - 25	300	
	RMSI63-32	32	15	22 - 32	380	
	RMSI63-40	40	18,5	28 - 40	480	
	RMSI63-52	52	22	36 - 52	600	
	RMSI63-63 ❷	63		45 - 63	600	

Circuit-breakers
up to 63 A







❶ Recommended value for standard 4-pole motors at 400 V AC 50 Hz. The start-up data and ratings for the motor to be protected are relevant.

❷ Device protection only.

Additional features - connection from right side of circuit-breaker ②

Type	Description	Ordering codes	Number of contacts	Width [mm]	Weight [kg]
NEW product   RSI-C11	Auxiliary contacts for RMSI25, RMSI63	RSI-C11	 1NC + 1NO	9	0,04
NEW product   RSI-S	Short-circuit indicator switch for RMSI25, RMSI63	RSI-S	 1NO + 1NC	9	0,04











Additional features - connection from left side of circuit-breaker ②

Type	Description	Ordering codes	Rated operating voltage	Width [mm]	Weight [kg]
NEW product   RSI-U	Undervoltage release for RMSI25, RMSI63	RSI-U230	230 V AC 50 Hz	18	0,11
		RSI-U240	240 V AC 50 Hz		
		RSI-U400	400 V AC 50 Hz		
		RSI-U415	415 V AC 50 Hz		
NEW product   RSI-W	Shunt release for RMSI25, RMSI63	RSI-W024 ④	24 V AC 50 Hz 24...60 V DC	18	0,11
		RSI-W230	230 V AC 50 Hz		
		RSI-W240	240 V AC 50 Hz		
		RSI-W400	400 V AC 50 Hz		
		RSI-W415	415 V AC 50 Hz		
		RSI-W11	110...240 V DC		
NEW product   RSI-M	Remote controlled operating mechanism for RMSI25	RSI-M	220...240 V AC 50/60 Hz	54	0,40

② Connection of additional features and accessories to circuit-breaker - see page 15

④ Can operate at AC or DC voltage.

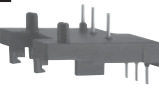
Accessories for circuit-breakers ⑥

Type	Description	Ordering codes	Circuit-breaker application	Weight [kg]
 NEW product  RSI-L	Insulated three-phase busbar modular spacing for RMSI25 Max. load: 63 A Rated voltage: 690 V Connection from above of circuit-breaker.	RSI-L02	for 2 circuit-breakers	0,05
		RSI-L03	for 3 circuit-breakers	
		RSI-L04	for 4 circuit-breakers	0,10
		RSI-L05	for 5 circuit-breakers	0,12
		RSI-L12	for 2 circuit-breakers with additional features	0,06
RSI-L14	for 4 circuit-breakers with additional features	0,12		
 NEW product  RSI-L	Three-phase feed-in terminal for RMSI25 Connection from above of circuit-breaker.	RSI-L21	Type I Conductor cross-sections: solid or stranded - 6...25 mm ² finely-stranded with sleeve - 4...16 mm ²	0,05
		RSI-L22	Type II Conductor cross-sections: solid or stranded - 6...25 mm ² finely-stranded with sleeve - 4...16 mm ²	0,03
 NEW product  RSI-L	Three-phase feed-in terminal for RMSI25 To be snapped onto the mounting rail instead of one circuit-breaker (see instruction).	RSI-L23	For mounting on 35 mm DIN rail mount, EN 50022 Conductor cross-sections: solid or stranded - 2,5...25 mm ² finely-stranded with sleeve - 2,5...16 mm ²	0,05
 NEW product  RSI-B04	Cover for terminals of busbars modular spacing RSI-L0., RSI-L1.	RSI-B04	Cover for terminals of busbars modular spacing, protection against shock or accidental short-circuiting when the circuit-breaker is omitted.	0,01
 NEW product  RSI-A	Adapter for connection circuit-breaker with mini-contactor	RSI-A	For RMSI25 circuit-breakers and CRMI05, CRMI09 mini-actuators ⑥	0,20

⑥ Connection of additional features and accessories to circuit-breaker - see page 15

⑥ Mini-actuators CRMI - see catalogue Relpol S.A. „Contactors - new line” or www.repol.com.pl

Mini-actuators up to 9 A, AC control

- CRMI05
- CRMI09



Technical data

Standards	DIN VDE 0660, IEC 60947-1, IEC 60947-2, IEC 60947-4-1		
Circuit-breakers	RMSI25	RMSI63	
Number of poles	3	3	
Max. rated current I_n	• plant protection • motor protection	25 A 25 A	63 A 52 A
Permissible ambient temperature	storage: -50 do +80 °C operating: -20...+55 °C		
Rated voltage	• operational U_e • insulation U_i • surge U_{imp}	690 V 750 V 6 kV	
Rated frequency	50/60 Hz		
Utilization category	• circuit-breaker • motor starter	A IEC 60947-2 AC3 IEC 60947-4-1	
Mechanical life (cycles)	• up to 25 A • upwards 25 A	10 ⁵	10 ⁵ 3 x 10 ⁴
Number of operating cycles/h (on load)		25	25
Protection category	with open terminals: IP 00 with conductors connected: IP 20		
Temperature compensation	Yes IEC 60947-4-1		
Phase failure sensitivity	Yes IEC 60947-4-1		
Auxiliary contacts, short-circuit indicator switch	RSI-C11, RSI-S		
Rated operational voltage U_e	230 V AC	400 V AC	500 V AC
Rated operational current I_e	3 A	1,5 A	1 A
Utilization category	AC15	AC15	AC15
Rated operational voltage U_e	L/R=200 ms: 24 V DC	L/R=200 ms: 60 V DC	L/R=200 ms: 220 V DC
Rated operational current I_e	2,3 A	0,7 A	0,3 A
Utilization category	DC13	DC13	DC13
Undervoltage release	RSI-U		
Power consumption	during pickup: 10 VA / 6 W in continuous operation: 4,7 VA / 2 W		
Tripping voltage	tripping: $0,35 < U_s < 0,7$ pick up: $0,85 < U_s < 1,1$		
Max. opening time	20 ms		
Shunt release	RSI-W		
Power consumption	during pickup: 10 VA / 6 W		
Tripping voltage	$0,7 < U_s < 1,1$		
Max. opening time	20 ms		
Remote controlled operating mechanism	RSI-M		
Rated control supply voltage U_s	220...240 V AC		
Power consumption	during pickup: 230 W in continuous operation: 5 W		
Tripping voltage	$0,85 < U_s < 1,1$		
Command duration	• min. • max.	at U_s : 0,25 s 5 s	
Total ON/OFF time	0,25 s / 0,04 s		
Main conductor cross-sections			
Soild or stranded [mm ²]	2×(1 to 6)	1×(1,5 to 2) × 16 or 1×(25+1) × 10	
Finely-stranded with sleeve [mm ²]	2×(1 to 4)	1×(1,5 to 2) × 10 or 1×(16+1) × 10	
Conductor cross-sections for additional features and accessories			
Soild or stranded [mm ²]	1×(0,5 to 2) × 2,5		
Finely-stranded with sleeve [mm ²]	1×(0,5 to 2) × 1,5		

Rated short-circuit breaking capacity

The table shows the rated ultimate short-circuit breaking capacity I_{cu} and the rated service short-circuit breaking capacity I_{cs} for the **RMSI25**, **RMSI63** circuit-breakers with respect to rated current I_n and rated operational voltage U_e . In the short-circuit-proof areas, I_{cu} is at least 100 kA. A backup fuse is therefore not necessary. In the other areas, when the short-circuit current at the installation point exceeds the rated short-circuit breaking capacity given in the table (below) for the circuit-breaker, the breaker must be protected by a backup fuse. See the following table for the maximum rated current for the backup fuse. With backup fuse according to the table, the maximum short-circuit current is permitted to equal the rated breaking capacity of the backup fuse.

Circuit-breaker	Rated current I_n	up to 240 V AC			up to 415 V AC			up to 440 V AC			up to 500 V AC			up to 690 V AC		
		I_{cu}	I_{cs}	Max. backup fuse (gL/gG)	I_{cu}	I_{cs}	Max. backup fuse (gL/gG)	I_{cu}	I_{cs}	Max. backup fuse (gL/gG)	I_{cu}	I_{cs}	Max. backup fuse (gL/gG)	I_{cu}	I_{cs}	Max. backup fuse (gL/gG)
Type	[A]	[kA]	[kA]	[A]	[kA]	[kA]	[A]	[kA]	[kA]	[A]	[kA]	[kA]	[A]	[kA]	[kA]	[A]
RMSI25	do 1 A	Short-circuit proof up to 100 kA. Backup fuse is not necessary.														
	1,6 A	Backup fuse is not necessary.														
	2,4 A															
	3,2 A, 4 A															
	5 A, 6 A															
	8 A, 10 A															
	13 A, 16 A															
	20 A, 25 A	10	10	100	6	6	80	5	5	80	3	3	80	2	2	80
RMSI63	do 2,4 A	Short-circuit proof up to 100 kA. Backup fuse is not necessary.														
	4 A	Backup fuse is not necessary.														
	6 A															
	10 A															
	16 A															
	25 A															
	32...63 A	35	17	200	25	13	200	25	13	200	10	5	200	4	4	160

Relation between short-circuit breaking capacity, related power factor and minimum short-circuit making capacity to IEC 60947-2

Short-circuit breaking capacity I [A]	Power factor $\cos\phi$	Short-circuit making capacity
$I \leq 3000$	0,9	$1,42 \times I$
$3000 \leq I \leq 4500$	0,8	$1,47 \times I$
$4500 \leq I \leq 6000$	0,7	$1,5 \times I$
$6000 \leq I \leq 10000$	0,5	$1,7 \times I$
$10000 \leq I \leq 20000$	0,3	$2,0 \times I$
$20000 \leq I \leq 50000$	0,25	$2,1 \times I$
$50000 \leq I$	0,2	$2,2 \times I$

Characteristic curves of RMSI25 circuit-breakers

The characteristic curves are obtained in the cold state and 3-pole loading. At operating temperature, the tripping time of the thermal releases drops by about 25%. With 3-pole loading, the deviation in tripping time for 3 times the current and upwards is $\pm 20\%$ in accordance with DIN VDE 0165.

The characteristic curves apply for a **RMSI25-6** circuit-breaker with a rated current of 6 A, a current setting range of 4 to 6 A.

Schematic representation of the time / current characteristic for RMSI25-6

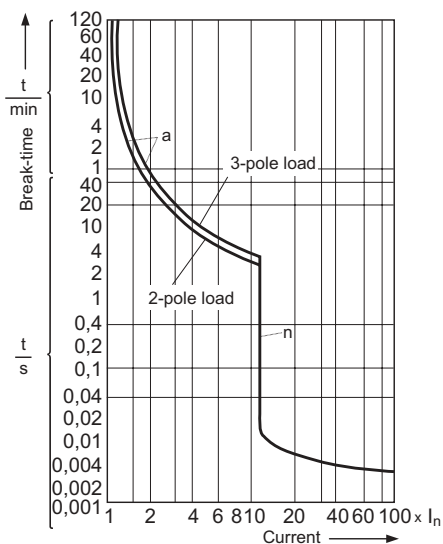

Current limiting characteristic for RMSI25-6

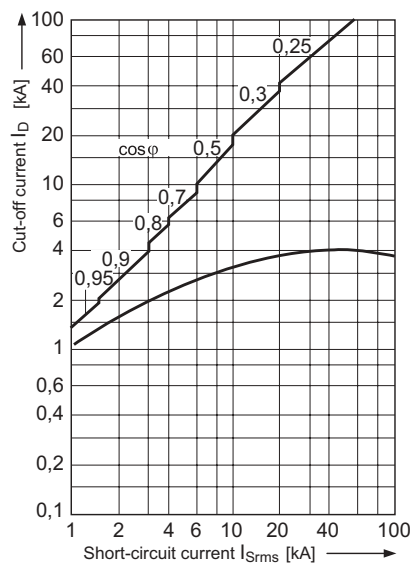

I²t characteristic for RMSI25-6

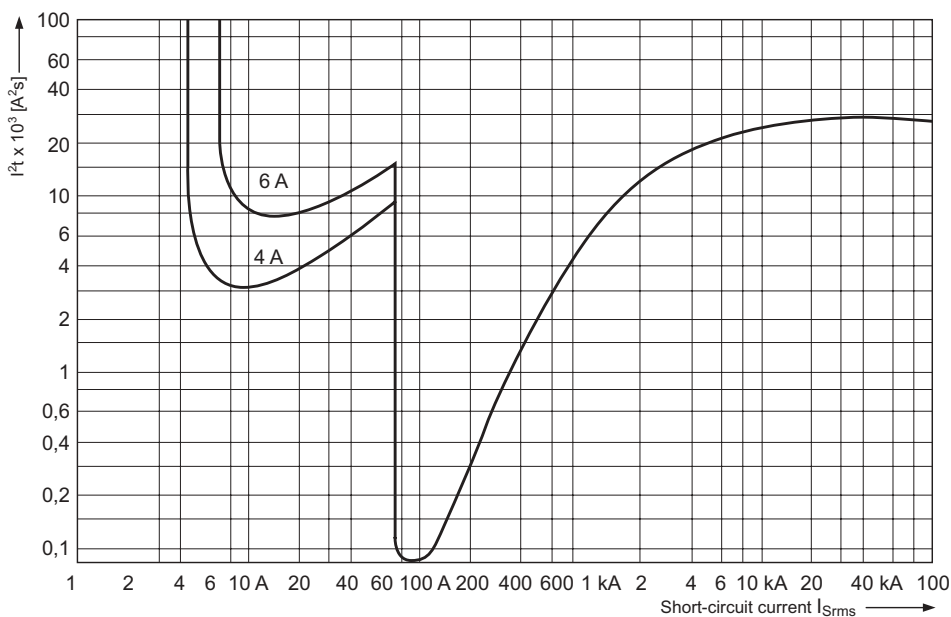

Characteristic curves of RMSI63 circuit-breakers

The characteristic curves are obtained in the cold state and 3-pole loading. At operating temperature, the tripping time of the thermal releases drops by about 25%. With 3-pole loading, the deviation in tripping time for 3 times the current and upwards is $\pm 20\%$ in accordance with DIN VDE 0165.

The characteristic curves apply for a **RMSI63-25** circuit-breaker with a rated current of 25 A and a tripping current for the instantaneous overcurrent release of 300 A, at a rated voltage of 400 V AC 50 Hz.

Schematic representation of the time / current characteristic for RMSI63-25

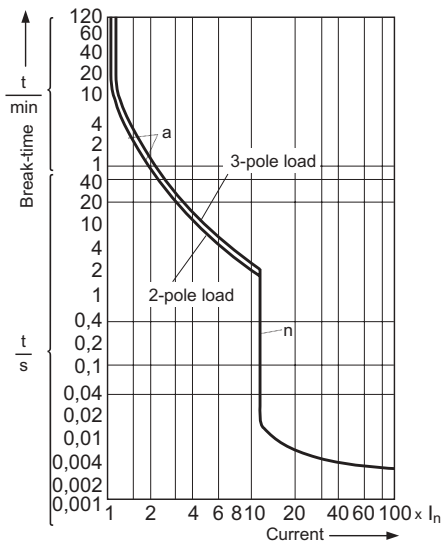

Current limiting characteristic for RMSI63-25

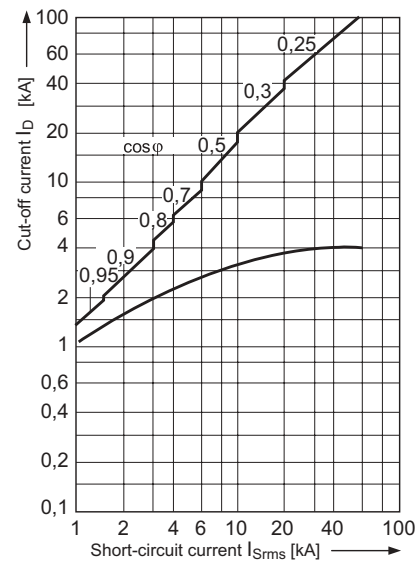

I²t characteristic for RMSI63-25

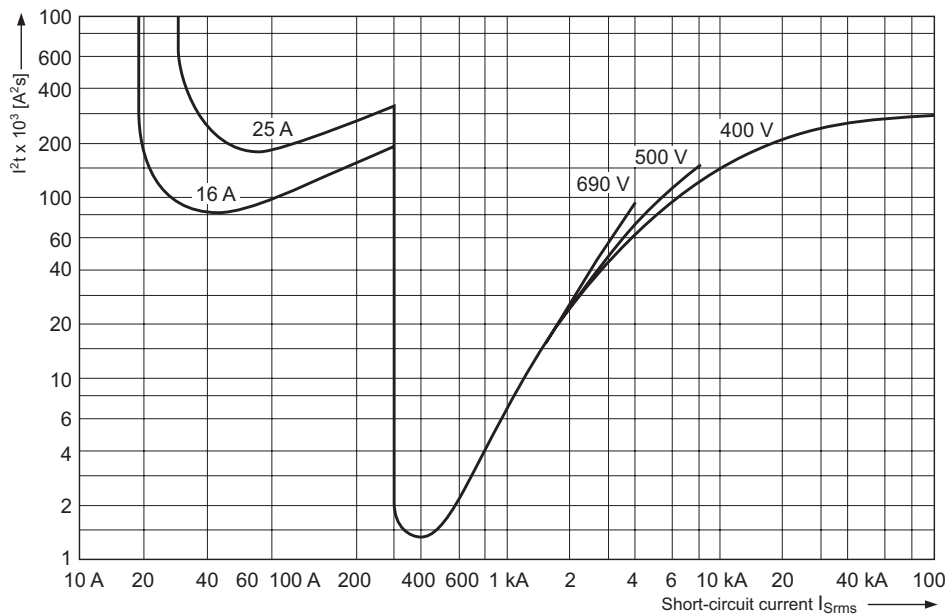

Connections diagrams

As defined by DIN 40713, the graphical symbols in the equipment circuit diagrams only provide information about the type, connection and operation of the devices, but not about their construction.

RMSI25 or RMSI63 circuit-breaker with additional features

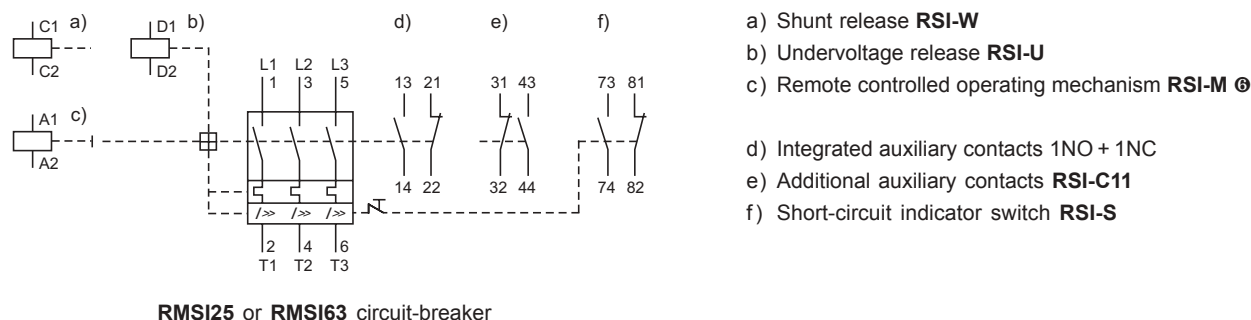

- a) Shunt release **RSI-W**
- b) Undervoltage release **RSI-U**
- c) Remote controlled operating mechanism **RSI-M** ⑥
- d) Integrated auxiliary contacts 1NO + 1NC
- e) Additional auxiliary contacts **RSI-C11**
- f) Short-circuit indicator switch **RSI-S**

RMSI25 or RMSI63 circuit-breaker with undervoltage release RSI-U

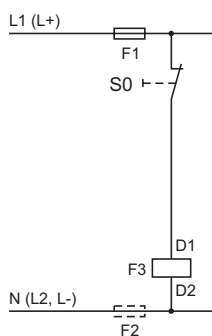

- S0 OFF button in control circuit
- S auxiliary contacts of the circuit-breaker

RMSI25 or RMSI63 circuit-breaker with shunt release RSI-W

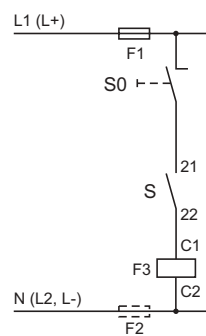

- S0 OFF button in control circuit
- S auxiliary contacts of the circuit-breaker

RMSI25 circuit-breaker with remote controlled operating mechanism RSI-M ⑥ ⑦

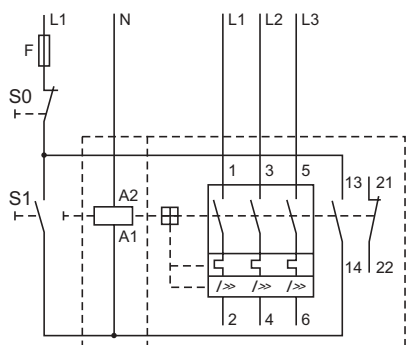

- S0 OFF button in control circuit
- S1 leading auxiliary contacts

- ⑥ Only for RMSI25 circuit-breakers.
- ⑦ 220...240 V AC 50/60 Hz, momentary-contact command 5 s (continuous command not permissible).

Dimensions

RMSI25 circuit-breaker and:

- a) Undervoltage release **RSI-U** or shunt release **RSI-W**
- b) Additional auxiliary contacts **RSI-C11**
- c) Short-circuit indicator switch **RSI-S**
- d) Remote controlled operating mechanism **RSI-M** ①

① Standard mounting on 35 mm DIN rail mount, EN 50022.

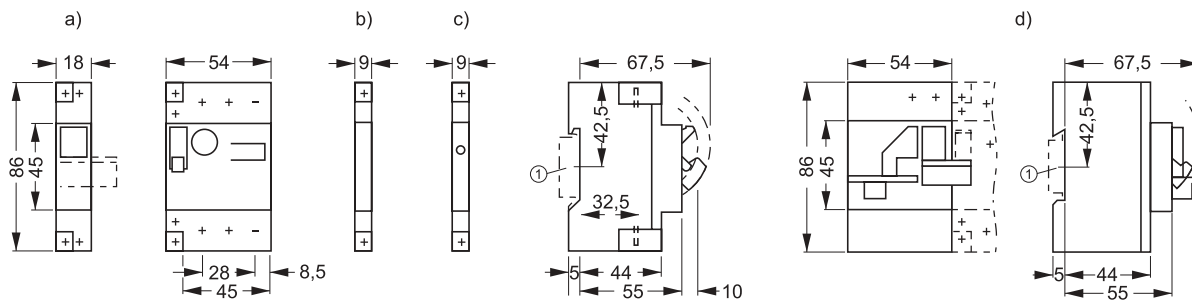

RMSI63 circuit-breaker and:

- a) Undervoltage release **RSI-U** or shunt release **RSI-W**
- b) Additional auxiliary contacts **RSI-C11**
- c) Short-circuit indicator switch **RSI-S**

① Standard mounting on 35 mm DIN rail mount, EN 50022.

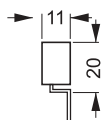
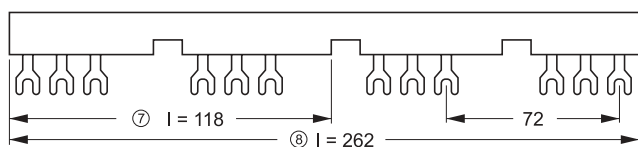
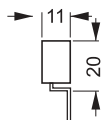
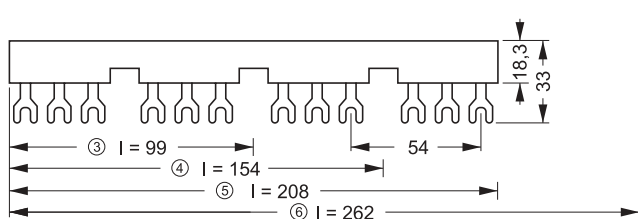
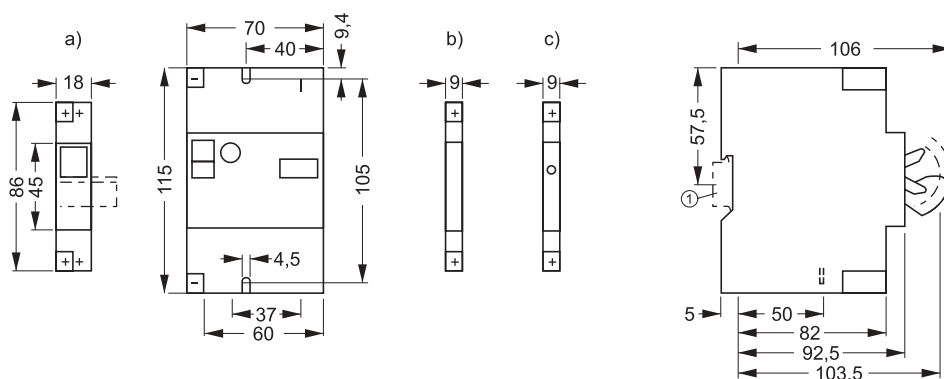

Insulated three-phase busbar modular spacing **RSI-L** ⑥

⑥ Only for RMSI25 circuit-breakers.

- ③ For 2 circuit-breakers **RSI-L02**
- ④ For 3 circuit-breakers **RSI-L03**
- ⑤ For 4 circuit-breakers **RSI-L04**
- ⑥ For 5 circuit-breakers **RSI-L05**
- ⑦ For 2 circuit-breakers with additional features **RSI-L12**
- ⑧ For 4 circuit-breakers with additional features **RSI-L14**

Dimensions

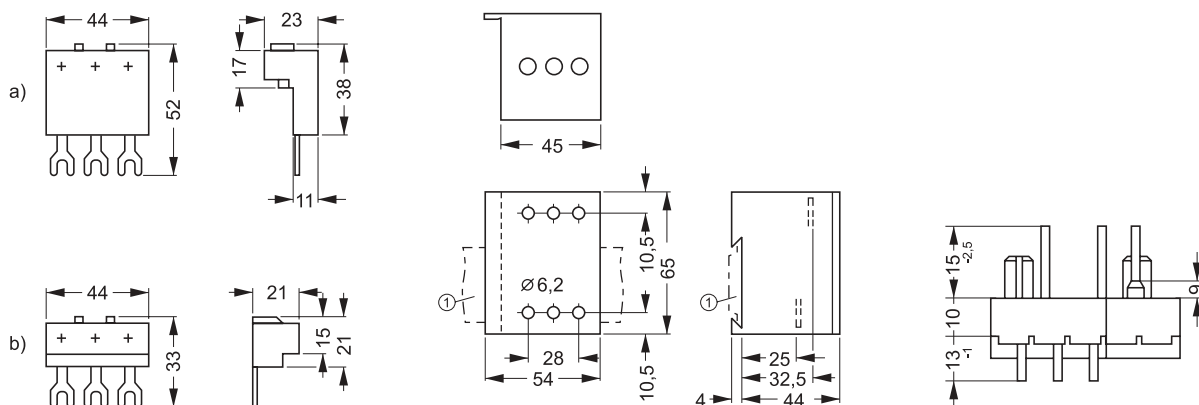

Three-phase feed-in terminal **RSI-L** ⑥:

- a) Type I **RSI-L21**
- b) Type II **RSI-L22**

⑥ Only for RMSI25 circuit-breakers.

Three-phase feed-in terminal **RSI-L23** ⑥

① Standard mounting on 35 mm DIN rail mount, EN 50022.

Adapter **RSI-A** ⑥

Requirement regarding space above arc chute

- 1) Minimum clearance with rated voltage to adjacent parts as well as non-insulated live parts.
- 2) The spacing of minimum 1cm with **RMSI25** and minimum 2 cm with **RMSI63** between large-surface covers and arc openings should be observed.
- 3) Uninsulated conductors must be insulated within the space required above arc chutes.

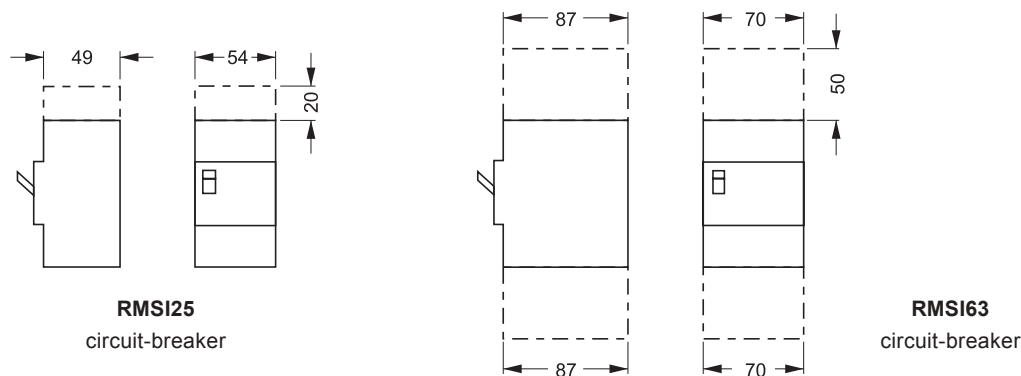

RMSI25
circuit-breaker

RMSI63
circuit-breaker

Permissible mounting positions for RMSI25, RMSI63 circuit-breakers

RMSI25, RMSI63 circuit-breakers permissible mounting position due to position of the operating parts, note DIN 43602.

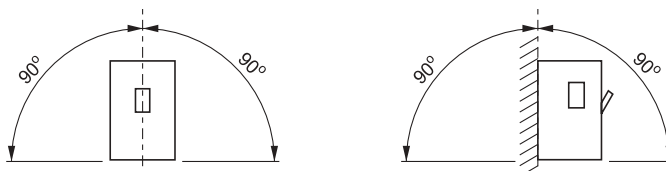

Returnable card ^{7E}

Kindly send this card by fax +48 68 37 43 830 or by letter.

1 Provide us, free of charge, following catalogues and marketing materials:

- CD - a set of catalogues**
- CD - a set of approvals, certificates and declarations
- Electromagnetic relays, interface relays, plug-in sockets and accessories for relays
- Contactors and thermal overload relays
- Time relays
- NEED programmable relays
- Solid State Relays
- I am interested in, free of charge, training in the area of the Relpol S.A. company offer.**

2 Client's remarks:

.....
.....

3 Client's details:

I am interested in the telephone or e-mail contact.

Send the offer to:

Full name

Company

Address

Zip code

Telephone Fax

E-mail

I agree to receive by e-mail commercial informations regarding promotions, news and other events connected to the activity of Relpol S.A. company. In this scope I make my e-mail address available to the above mentioned company.

.....
Date

.....
Signature

We thank you for submitting this card to the Relpol S.A. company.

RELPOL S.A.
ul. 11 Listopada 37
68-200 Żary, Poland
e-mail: relpol@relpol.com.pl

Export Sales Department Phone +48 68 47 90 832
Fax +48 68 47 90 837, e-mail: export@relpol.com.pl
Marketing Department Phone +48 68 47 90 900
e-mail: marketing@relpol.com.pl

www.relpol.com.pl

Three-phase feed-in terminals
RSI-L21, RSI-L22



Insulated three-phase busbar modular spacing
RSI-L

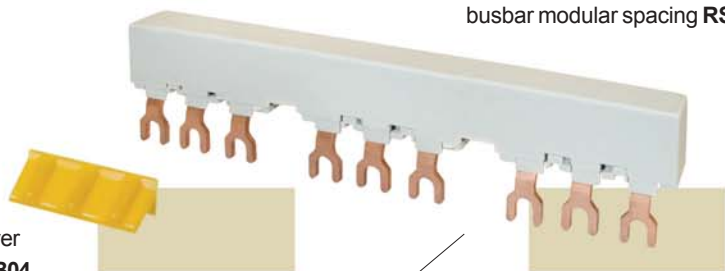

Cover
RSI-B04



Undervoltage release
RSI-U



Circuit-breaker
RMSI25

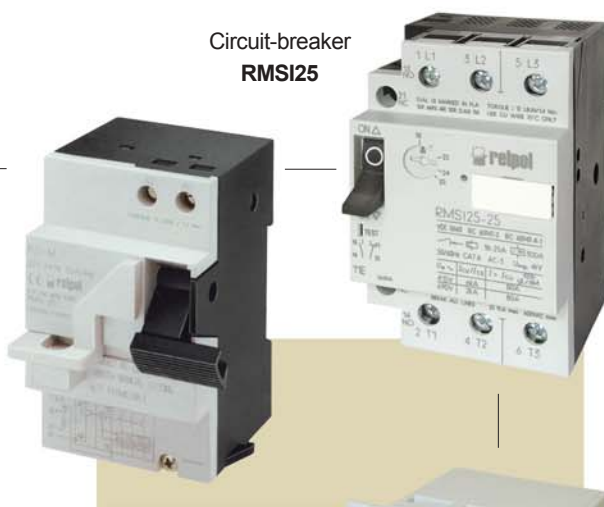

Auxiliary contacts
RSI-C11



Remote controlled operating mechanism
RSI-M



Shunt release
RSI-W

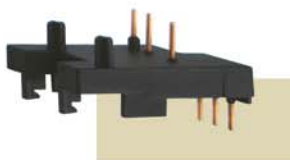

Adapter
RSI-A

Short-circuit indicator switch
RSI-S



Three-phase feed-in terminal
RSI-L23



Circuit-breaker
RMSI63

Additional features and accessories for **RMSI25**

Additional features and accessories for **RMSI63**



Project part - financed by the EUROPEAN UNION
European Regional Development Fund



UNION FOR ENTERPRISING PEOPLE
COMPETITIVENESS PROGRAMME

Due to the permanent development policy, Relpol S.A. reserves the right to introduce changes of data and characteristics of the products. The devices shall be operated by skilled personnel in accordance with the regulations in force pertaining to electrical systems. The technical data are of informational nature. Thus, Relpol S.A. does not accept any liability for inappropriate use of the presented products.

The offer of Relpol S.A.
includes the following products:

- **subminiature signal relays**
rated switching capacity: from 1 A to 3 A,
coil voltage range: from 3 V to 48 V DC
- **miniature relays**
rated switching capacity: from 5 A to 20 A
- **industrial relays**
rated switching capacity: from 5 A to 30 A,
mounting: to plug-in sockets on 35 mm DIN rail mount,
EN 50022 or on panel mounting, for PCB
- **interface relays**
rated switching capacity: from 0,5 A to 16 A,
number of contacts: from 1 to 4
- **plug-in sockets for relays**
PCB plug-in sockets, plug-in sockets
for 35 mm DIN rail mount, EN 50022
- **contactors**
rated switching power: from 2,2 kW to 200 kW
/at 400 V/
- **motor protection circuit breakers**
setting range: from 0,1 A to 63 A
- **time relays**
single- and multifunction time relays,
wide range of time adjustments
- **monitoring relays**
monitoring of current, voltage, temperature
- **NEED programmable relays**
versions: 8 inputs / 4 relay outputs,
16 inputs / 8 relay outputs, programming: LAD, STL,
supply voltages: 230 V AC, 24 V DC, 12 V DC,
LED indicators of the relay and input / output status
- **RPS - DIN rail power supply**
for automation systems, output circuit: 12 or 24 V DC,
rated currents: from 1,5 A to 10 A
- **solid state relays**
rated load currents: from 1 A to 100 A,
switching at zero or at any time
- **overvoltage arresters**
classes I, II and III, available with changeover
signal contact
- **switches and rotary switches**
lever switches of 1-, 2-, 3- and 4-pole versions,
rotary switches from 1 to 6 sections
and from 2 to 12 positions
- **digital protection sets for automation,
measurements and control
for mid-voltage fields**
- **production and installation
of stationary devices for monitoring
of radioactive radiation**



RELPOL S.A.
ul. 11 Listopada 37
68-200 Żary, Poland
e-mail: relpol@relpol.com.pl
www.relpol.com.pl
Export Sales Department
Phone +48 68 47 90 832
Fax +48 68 47 90 837
e-mail: export@relpol.com.pl
Marketing Department
Phone +48 68 47 90 900
e-mail: marketing@relpol.com.pl

RELPOL M Minsk / Belarus
Phone +375 17 298 44 11
e-mail: info@relpol-m.com

RELPOL BG Varna / Bulgaria
Phone +359 5 261 02 57
e-mail: office@relpol.biz

RELPOL HUNGARY Budapest / Hungary
Phone +361 265 19 71
e-mail: relpol@relpol.hu

RELPOL BALTIJA Vilnius / Lithuania
Phone +370 5 275 23 01
e-mail: baltija@relpol.com.pl

RELPOL ELTIM Sankt-Petersburg / Russia
Phone +7 812 327 35 99
e-mail: relpol@mail.ru

RELPOL ALTERA Kiev / Ukraine
Phone +380 44 496 18 88
e-mail: svaltera@svaltera.kiev.ua

RELPOL FRANCE Paris / France
Phone +33 1 60 798 500
e-mail: relpol.france@relpol.fr

RELPOL LTD. London / England
Phone +44 1582 487707
e-mail: phil@relpol.com.pl

www.relpol.com.pl